



Scintilla Soldering Course

16 + (17) October 2023



Planning

Lecture

- ⚡ What is soldering?
- ⚡ Electronic components
- ⚡ Soldering techniques
- ⚡ Finding and fixing errors
- ⚡ Principles of the kit

Practical

- ⚡ Planning your lay-out
- ⚡ Assembling your lay-out
- ⚡ Soldering the components
- ⚡ Testing
- ⚡ Debugging
- ⚡ Testing
- ⚡ Etc.



What is soldering?

Breadboard

- ⚡ For testing
- ⚡ Temporary
- ⚡ Fragile
- ⚡ Not suitable for high frequencies

Soldering

- ⚡ Permanent
- ⚡ Rigid and proper electrical connections
- ⚡ Durable

What is soldering?

Through-hole (THT)

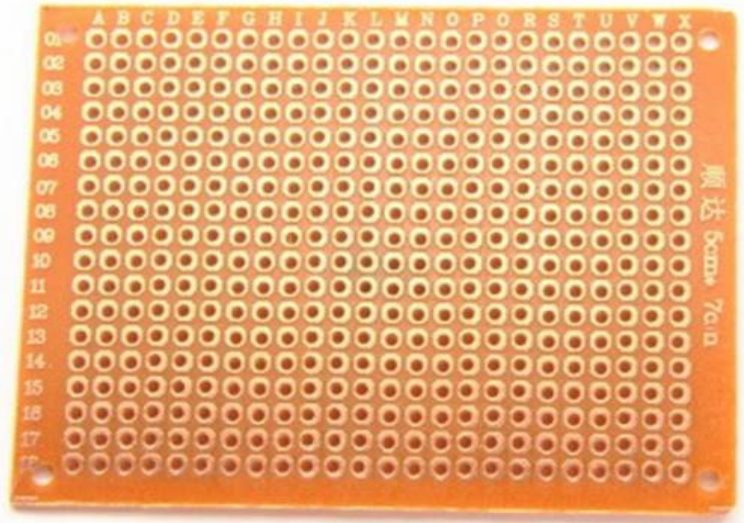

Surface mount (SMD)

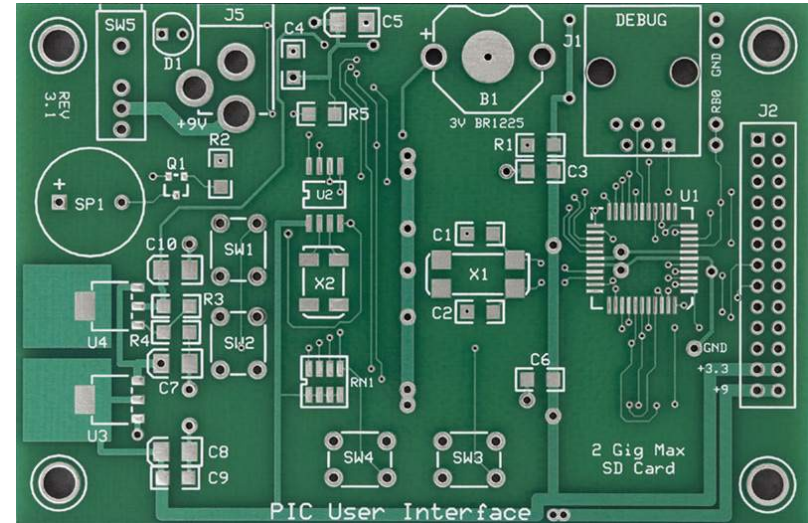



What to take into account?

Electronic Components

Resistors

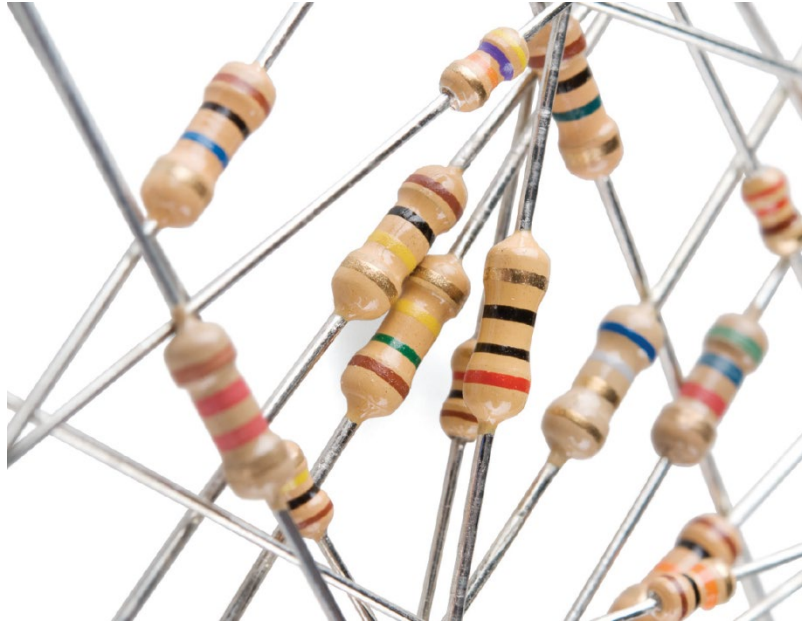

Capacitors

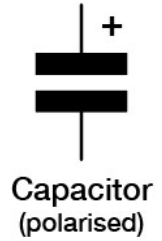
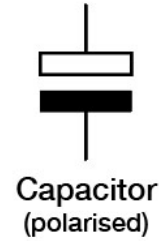
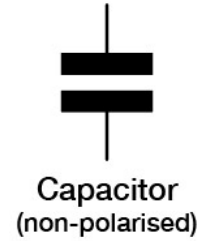
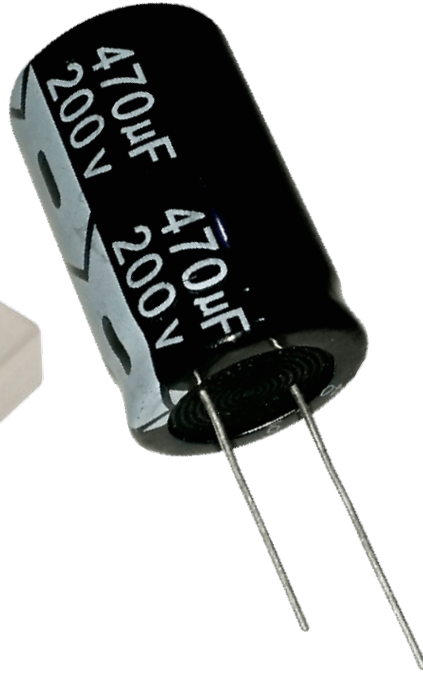

Alternatives

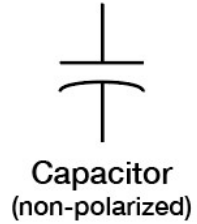
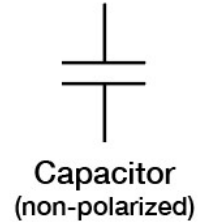
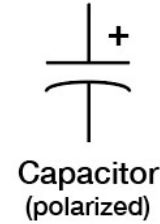

Polarized Components

Only possible to connect in 1 direction

- 📡 Long side usually '+'
- 📡 White stripe usually '-'



*Not sponsored
** Not affiliated to Duracell do-group

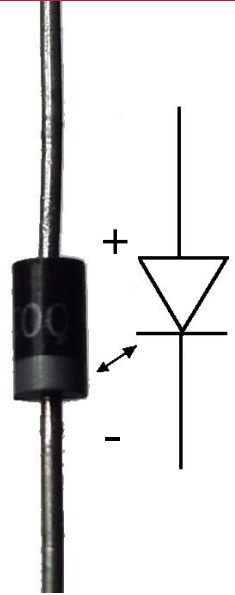
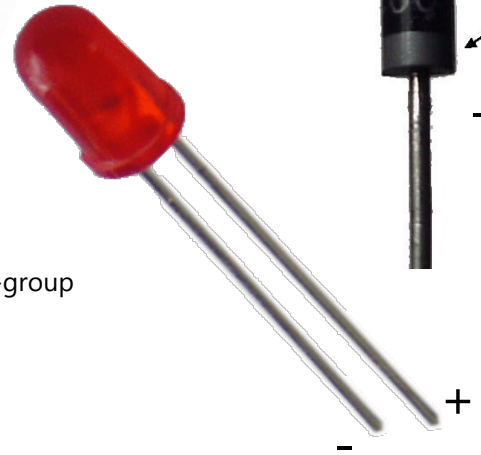

Help it has more pins!?

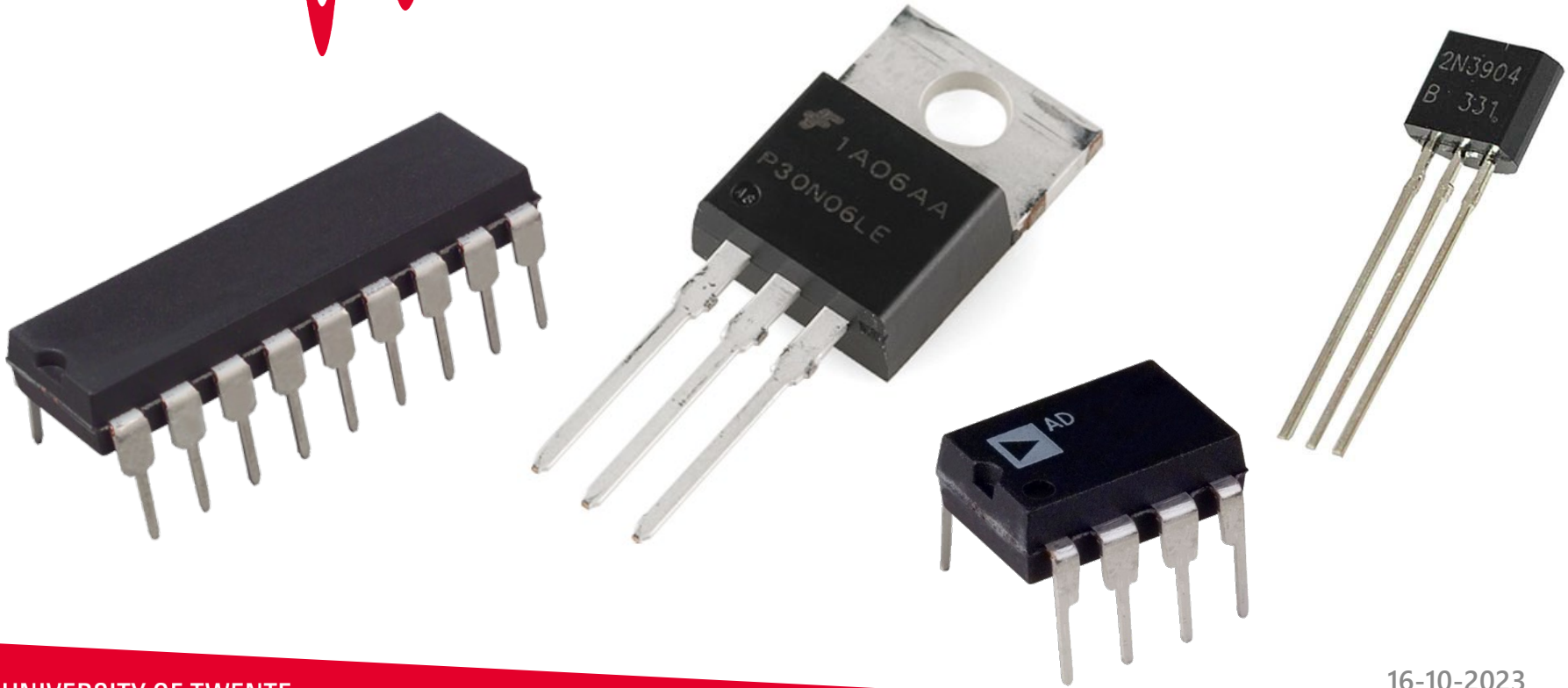

Reading Datasheets

What can you find?

- 📡 Maximum ratings
- 📡 Common applications
- 📡 Electrical characteristics
- 📡 Pin layout(!)



FAIRCHILD
SEMICONDUCTOR

MJE3055T

General Purpose and Switching Applications

- DC Current Gain Specified to $I_C = 10A$
- High Current Gain-Bandwidth Product: $f_T = 2MHz$ (Min.)

MJE3055T



TO-220
1.Base 2.Collector 3.Emitter

NPN Silicon Transistor

Absolute Maximum Ratings $T_C = 25^\circ C$ unless otherwise noted

Symbol	Parameter	Value	Units
V_{CE0}	Collector-Base Voltage	70	V
V_{CE0}	Collector-Emitter Voltage	60	V
V_{EB0}	Emitter-Base Voltage	5	V
I_C	Collector Current	10	A
I_B	Base Current	6	A
P_C	Collector Dissipation ($T_C = 25^\circ C$)	75	W
P_C	Collector Dissipation ($T_C = 25^\circ C$)	0.6	W
T_J	Junction Temperature	150	$^\circ C$
T_{STG}	Storage Temperature	-55 ~ 150	$^\circ C$

Electrical Characteristics $T_C = 25^\circ C$ unless otherwise noted

Symbol	Parameter	Test Condition	Min.	Max.	Units
BV_{CE0}	Collector-Emitter Breakdown Voltage	$I_C = 200mA, I_B = 0$	60		V
I_{CE0}	Collector Cut-off Current	$V_{CE} = 30V, I_B = 0$		700	μA
I_{CEX1}	Collector Cut-off Current	$V_{CE} = 70V, V_{BE}(OFF) = -1.5V$		1	mA
I_{CEX2}		$V_{CE} = 70V, V_{BE}(OFF) = -1.5V$ @ $T_C = 150^\circ C$		5	
I_{EB0}	Emitter Cut-off Current	$V_{BE} = 5V, I_C = 0$		5	mA
h_{FE}	DC Current Gain	$V_{CE} = 4V, I_C = 4A$ $V_{CE} = 4V, I_C = 10A$	20 5	100	
$V_{CE(sat)}$	Collector-Emitter Saturation Voltage	$I_C = 4A, I_B = 0.4A$ $I_C = 10A, I_B = 3.3A$		1.1 8	V V
$V_{BE(on)}$	Base-Emitter On Voltage	$V_{CE} = 4V, I_C = 4A$		1.8	V
f_T	Current Gain Bandwidth Product	$V_{CE} = 10V, I_C = 500mA$	2		MHz

* Pulse test: PW<300 μs , duty cycle<2% Pulse

Transistor

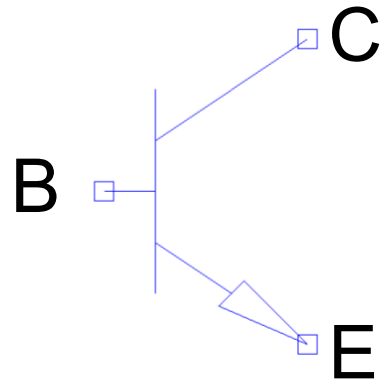
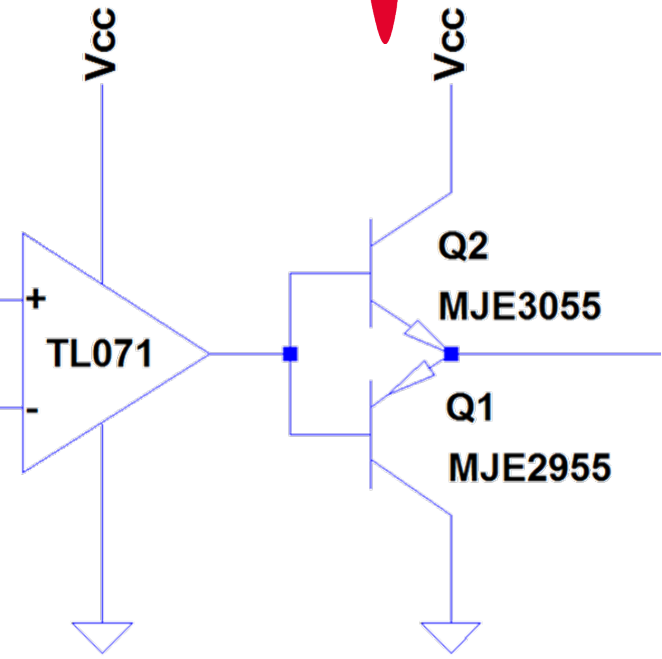
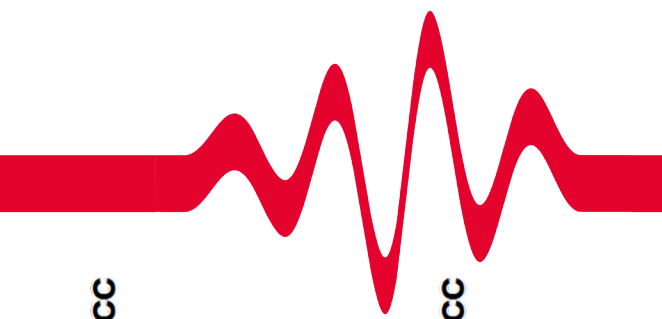

Heat sink might be connected to one of the pins!

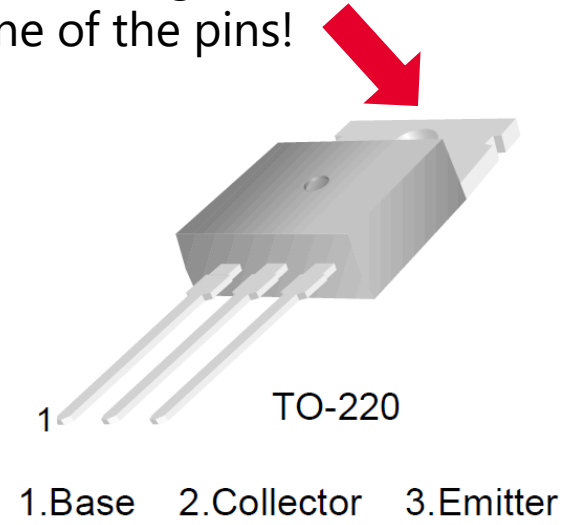

Op-Amp

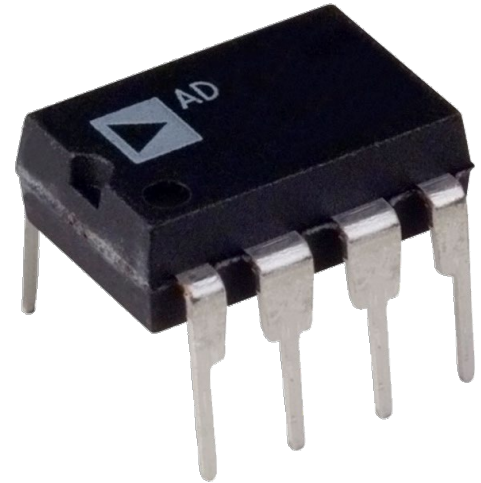
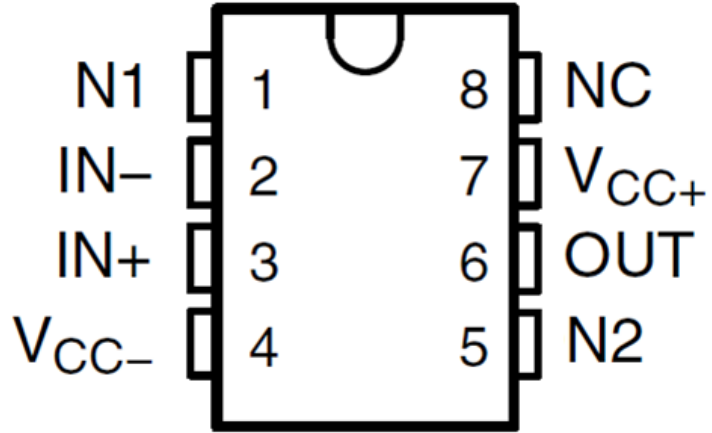
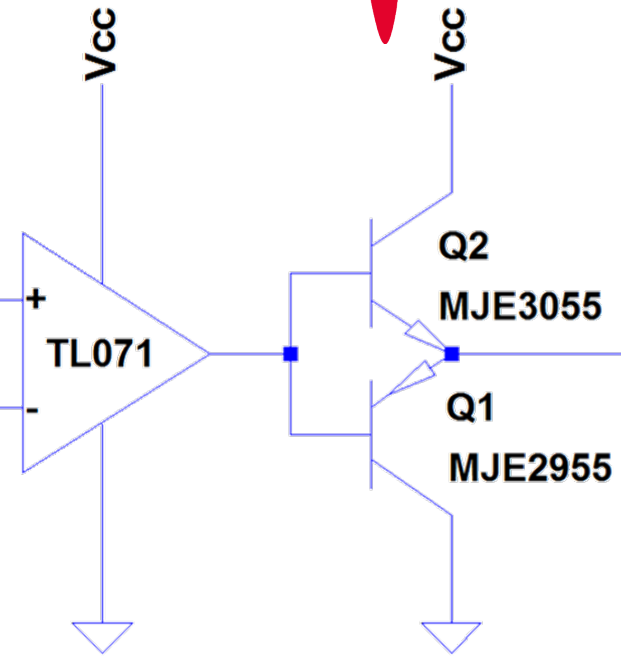
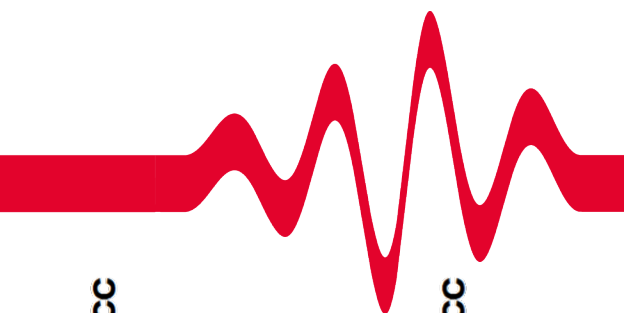

IC Sockets

What are they used for?

- Easy to replace components
- Prevents overheating during soldering





Do's and don'ts

Soldering techniques

Sorts of tin

- 📡 Unleaded solder ~330°C
 - Has an expiration date
 - Uses flux core
- 📡 Leaded solder ~230°C
 - Higher melting point
 - Toxic fumes
 - Easier to solder
- 📡 Flux
 - 'Repairs' oxidized metals



How to do it correctly

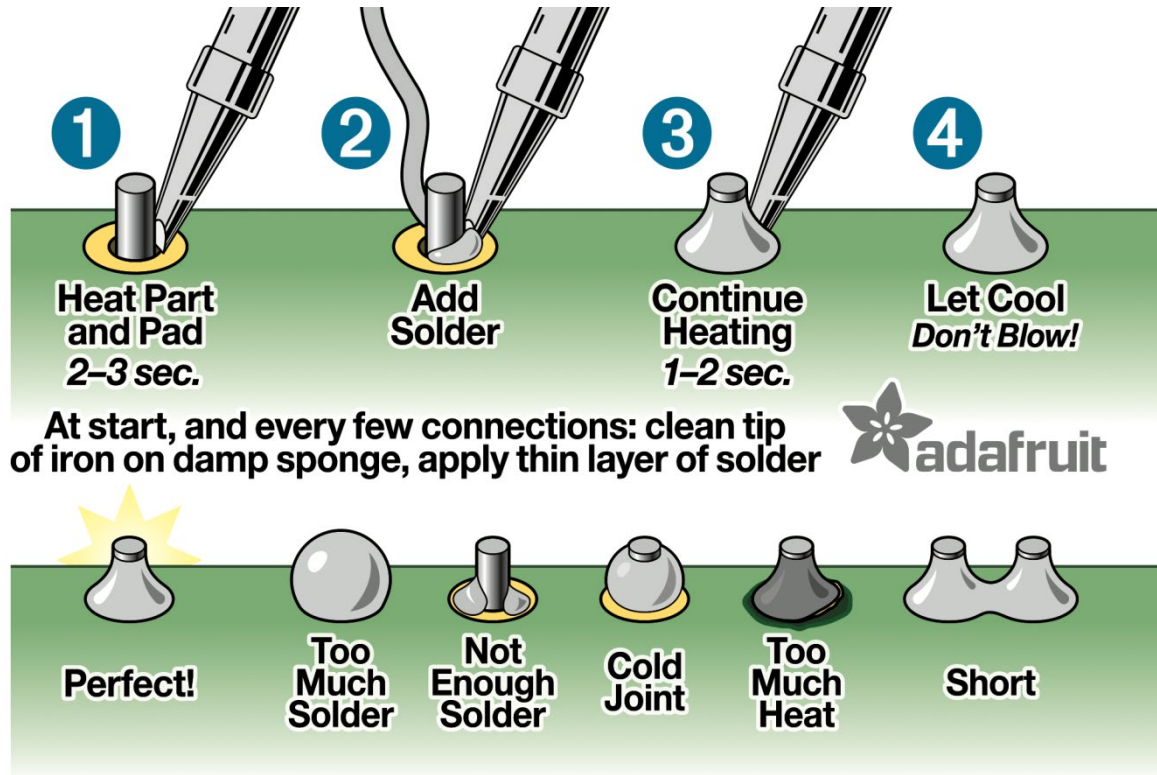

Correct Joint

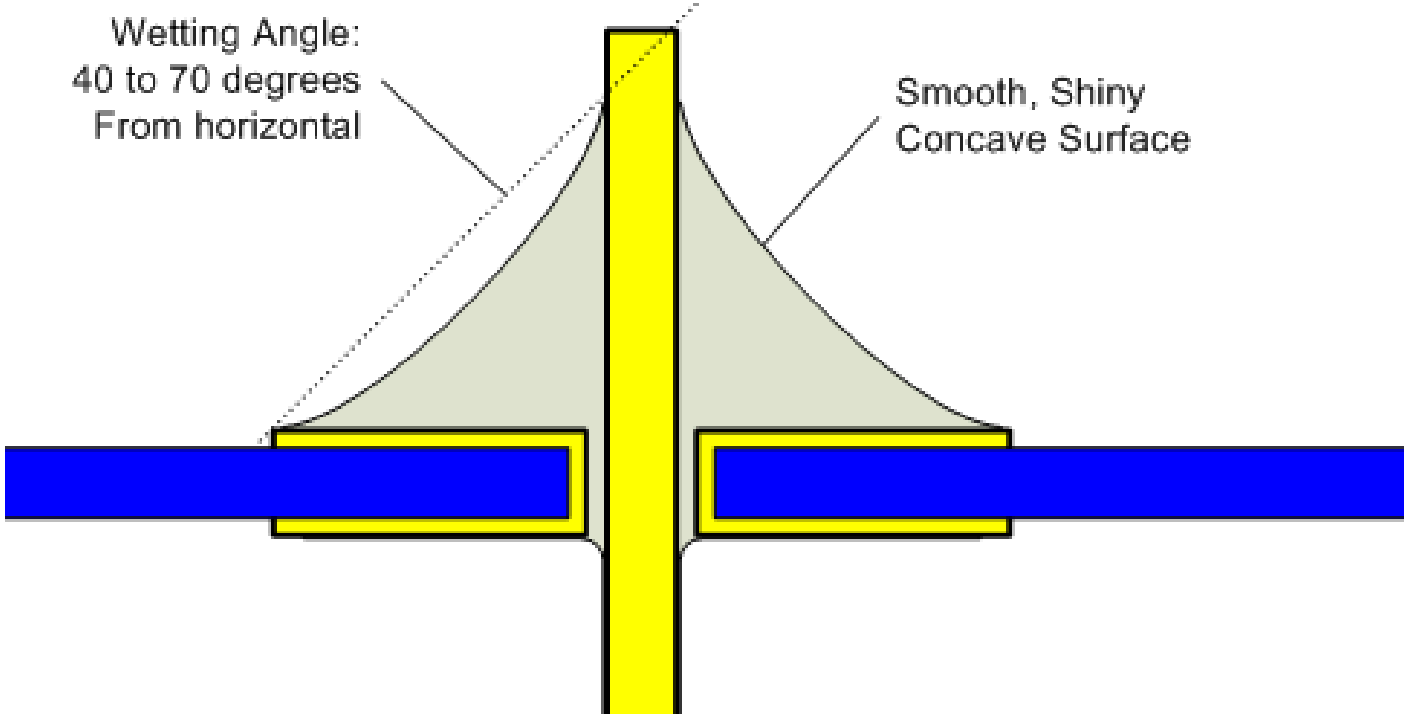

Cold Joint

Cause: cold metal

Solution: Reheat (and add new solder/flux)



Dry Joint

**Cause: Movement
during cooling**

Solution: Reheat



Connections

Using Component Legs

- ⚡ Saves effort and solder
- ⚡ Use the components to make a bridge

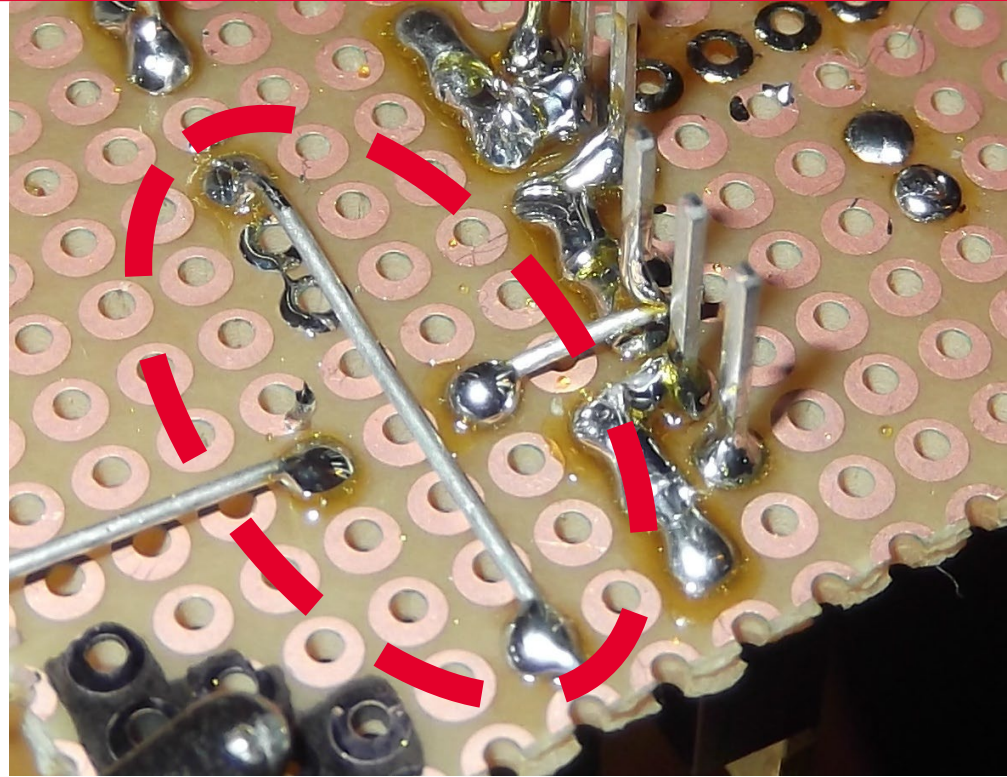

Connections

Using Solder Bridges

- Connects nearby components
- Use tin to make the connection

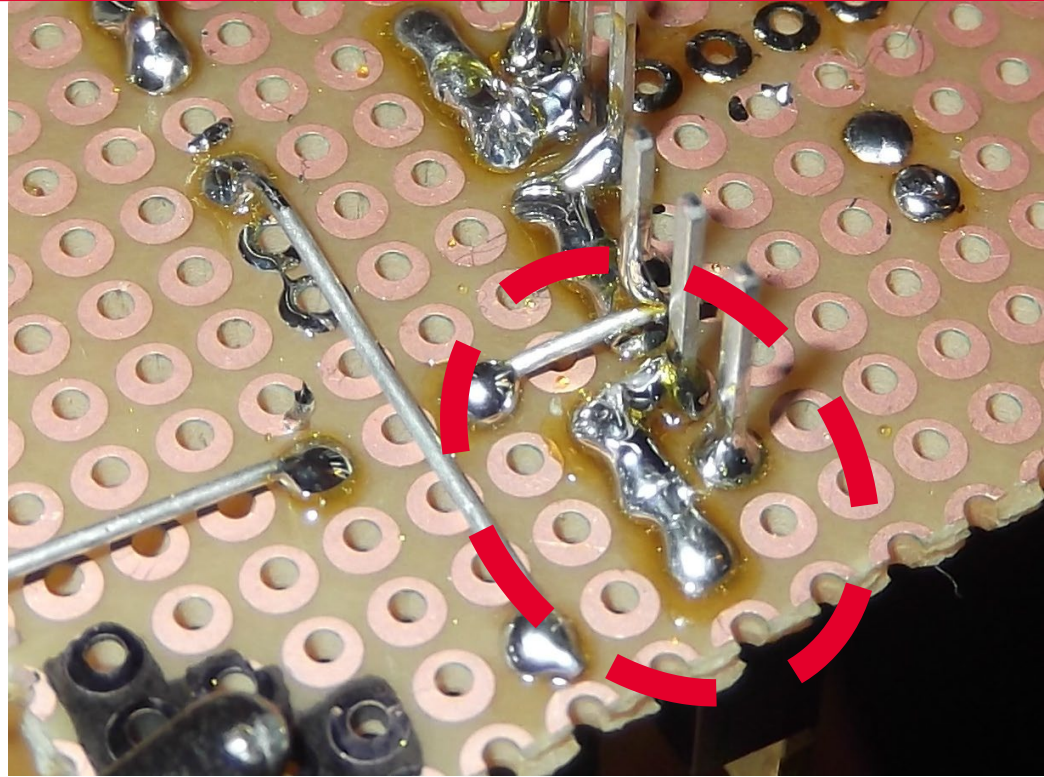

Connections

Using Wire Bridges

- 📡 Covers large distances
- 📡 Makes circuit chaotic
- 📡 Try to avoid these!

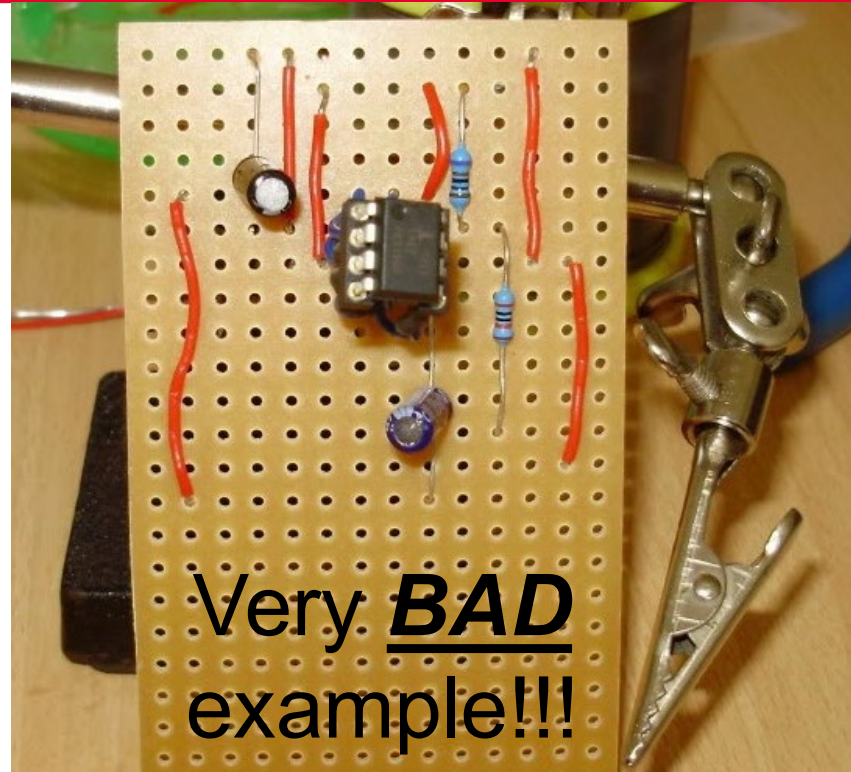

Fitting Components

Keep it tidy!

- Make sure components are flush with the PCB
- Avoid using wires
- Do not connect the IC until after soldering

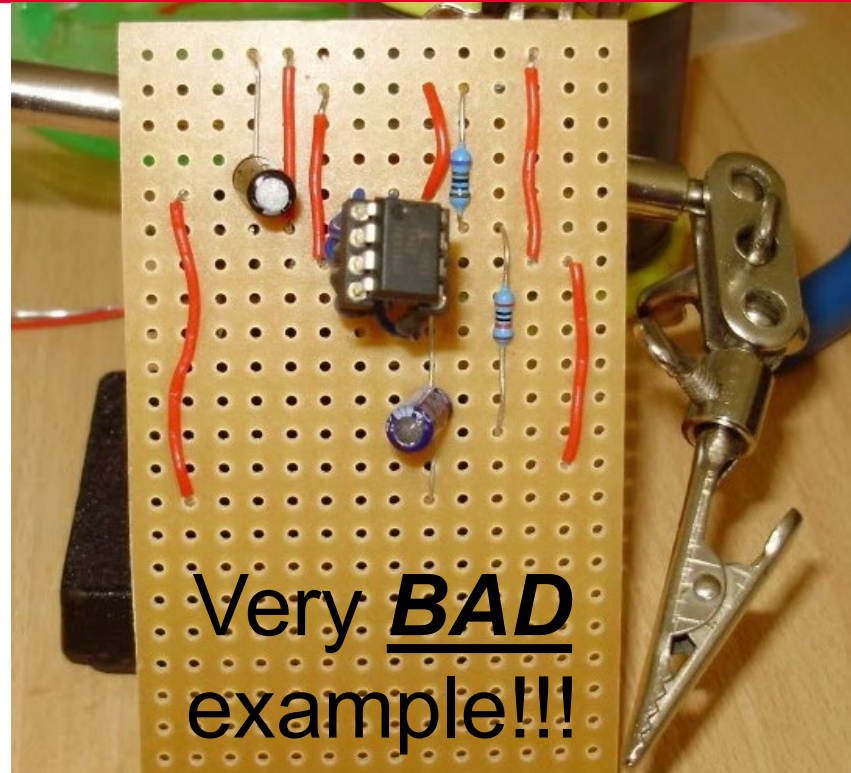

Soft Core Wires

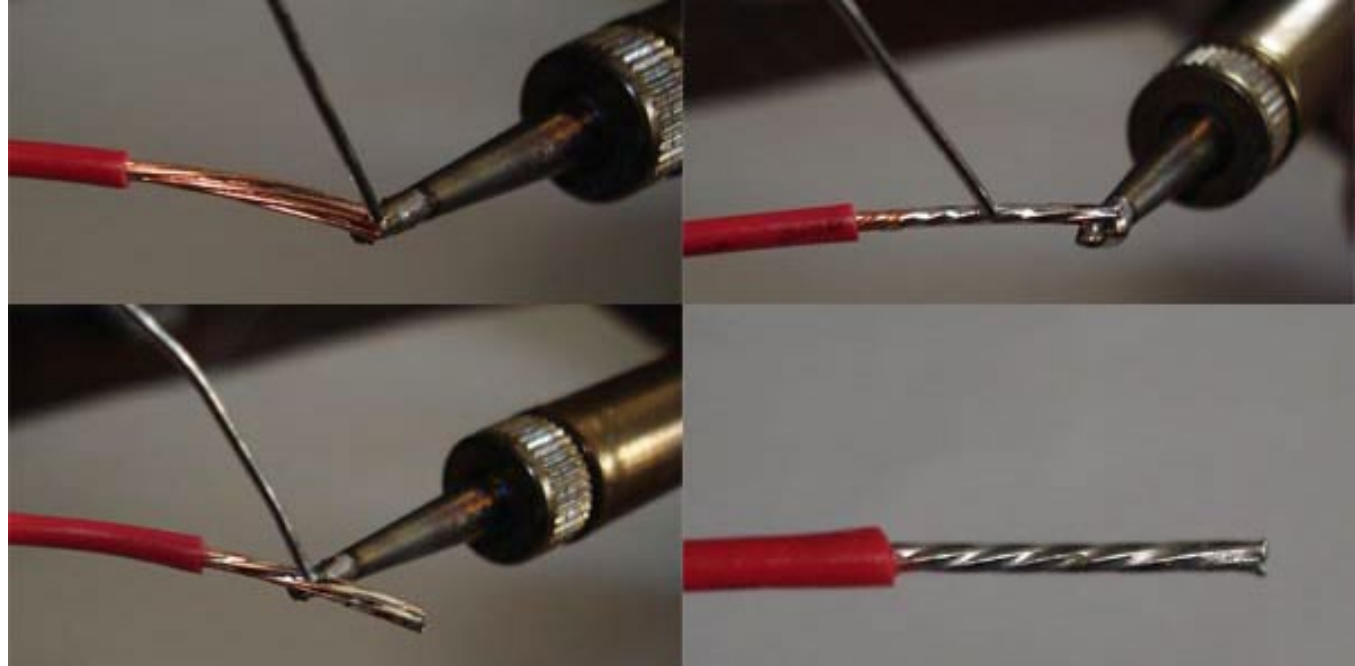



And fixing them!

Finding Errors

Finding errors

- 📡 Visual inspection
- 📡 Voltage measurements at critical points
- 📡 Follow the signal
- 📡 Common errors:
 - Missing connections
 - Short circuits
 - Cold joints
 - Dry joints

Visual Inspection

Clearly not finished

Fast and simple method to find faulty or missing connections

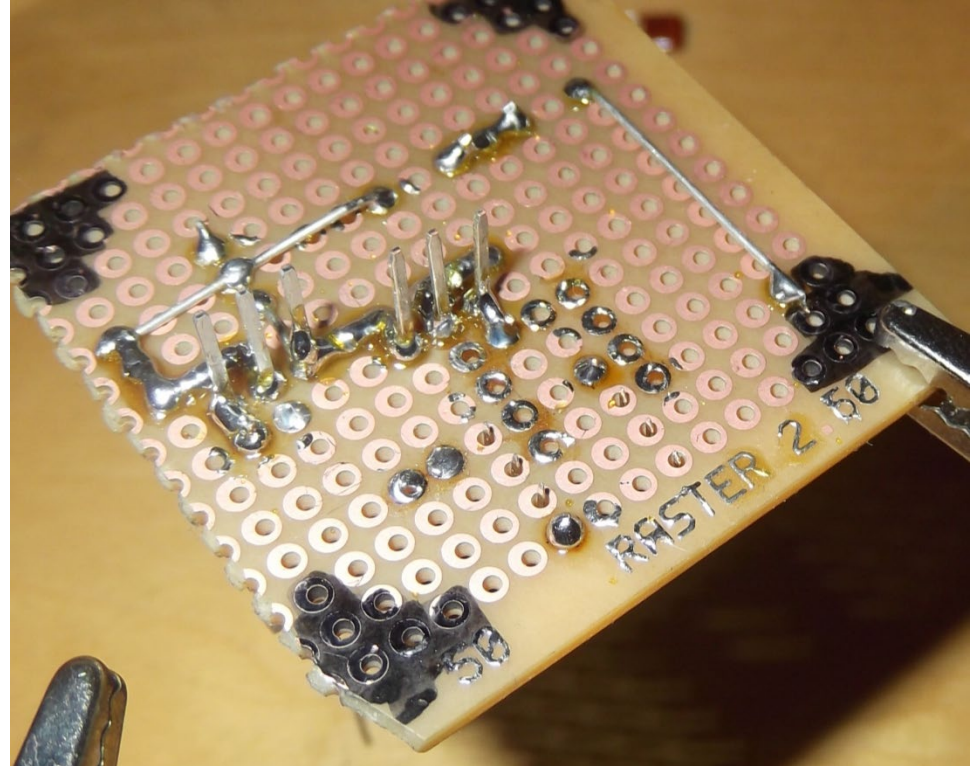

Voltage measurement

What voltages do you expect at every node?

- 📡 Check DC first
- 📡 Then follow the signal through the circuit

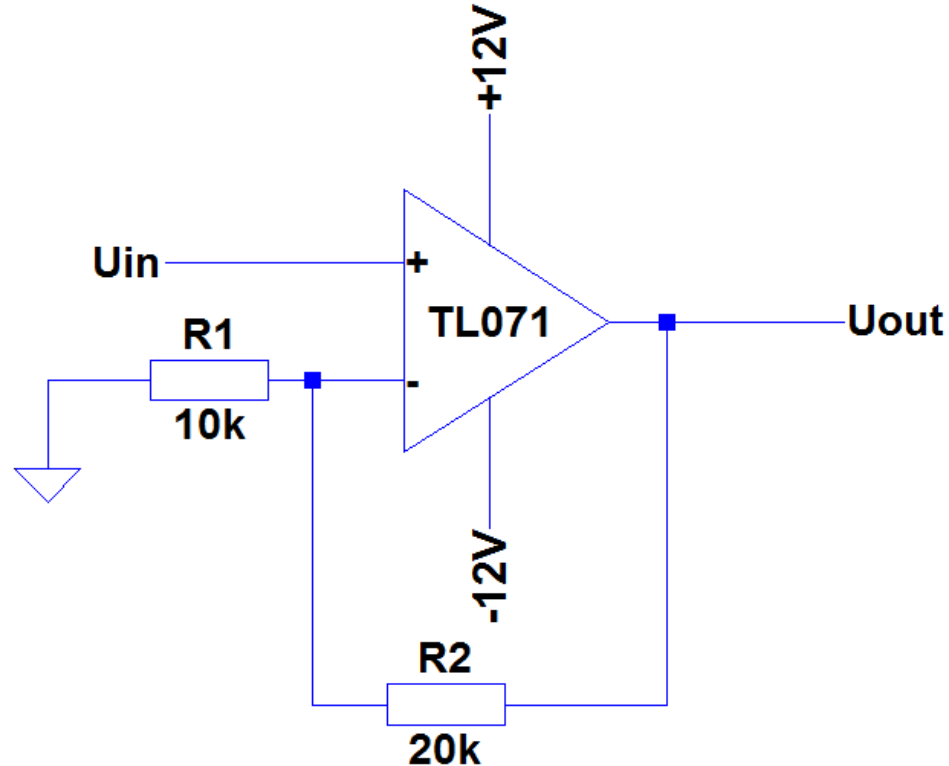

Fixing errors

Desoldering Pump



Desoldering Wick

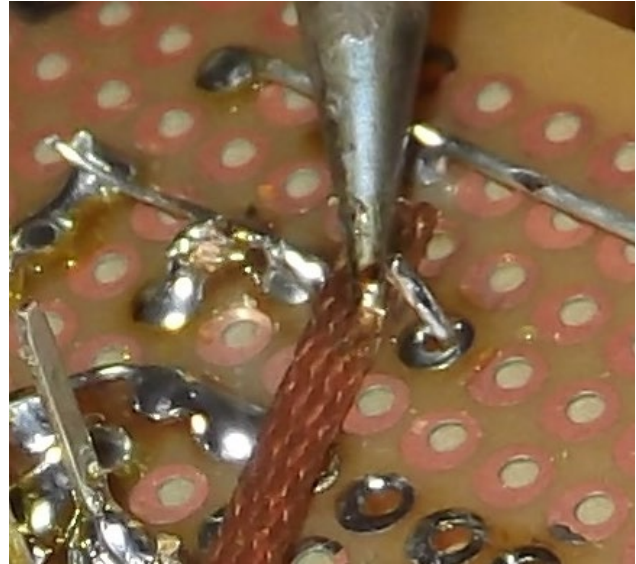



Audio Amplifier

The Practical

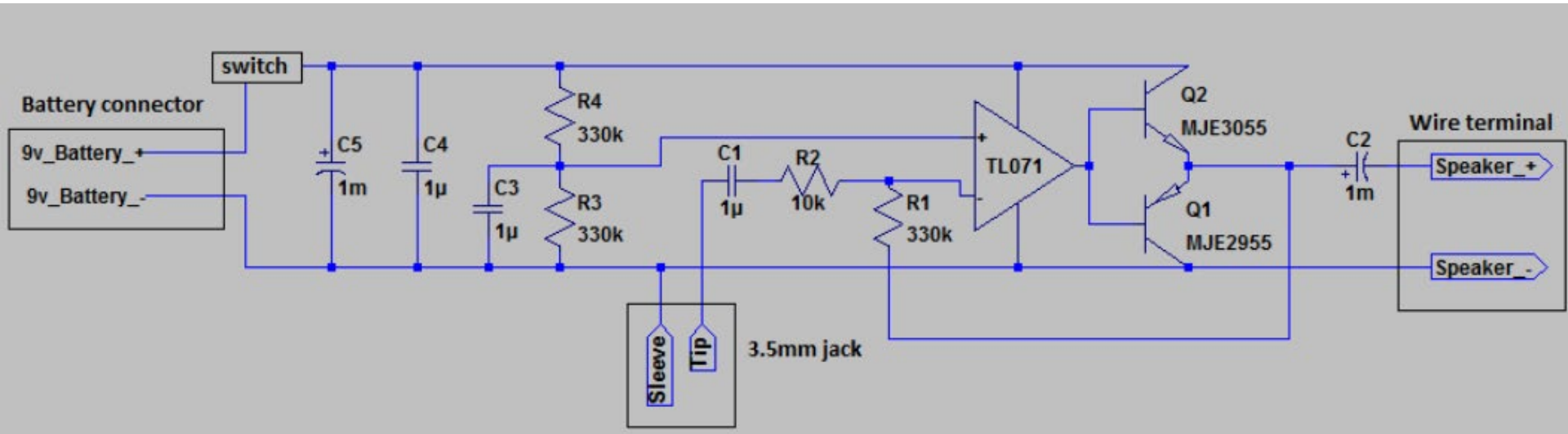

Jack Plug

Mono amplifiers only use the **left** channel

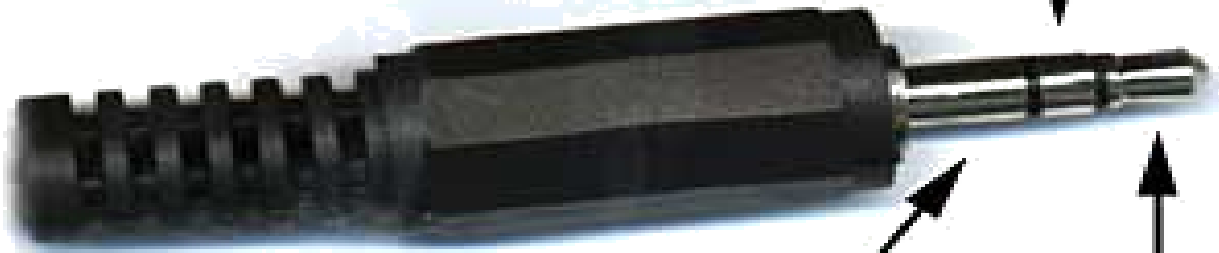

Right channel

Ring



Sleeve

Ground

Tip

Left channel

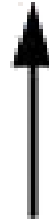

Connecting the Jack

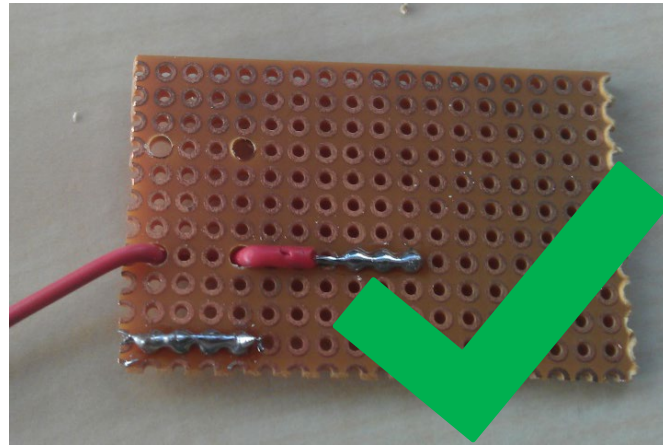
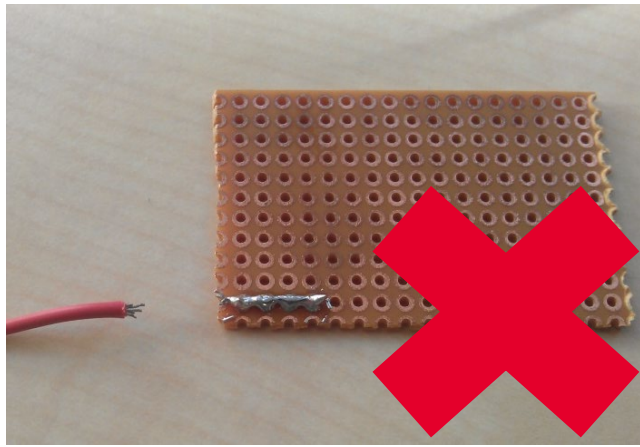
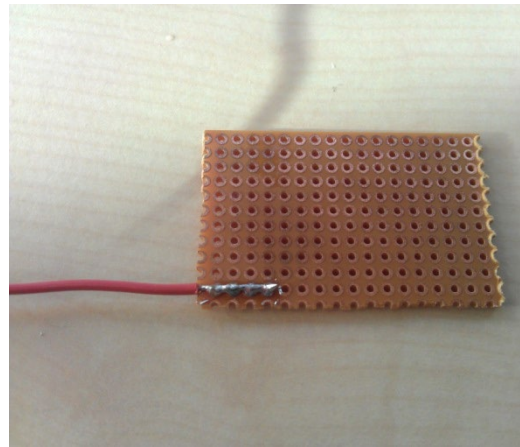

Final Product

How to get here?

- 📡 Analyse the circuit diagram
- 📡 Make a layout on the PCB
- 📡 Insert the components and solder them

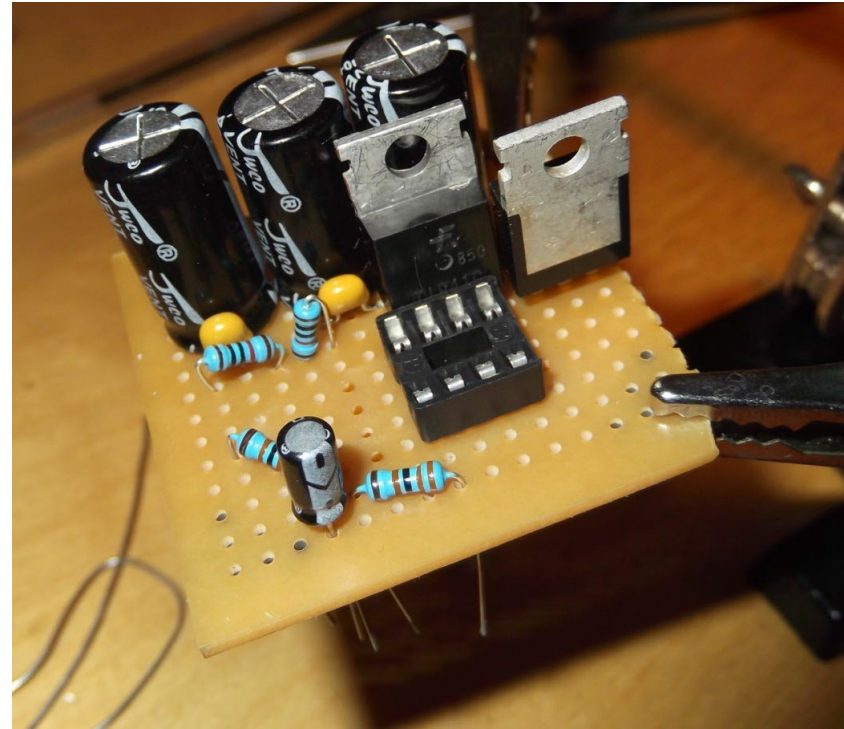



Final Product

- ✦ Taking the schematic and placing the components on the PCB is very time consuming
- ✦ **This process will take (most of) the evening!**
- ✦ We have therefore also made a layout for you if you just want to solder!



Documentation!

<https://docs.scintilla.utwente.nl/masterclass/SolderingCourse2023>

Or just <https://bit.ly/soldercourse2023>



Good luck and happy soldering!

You can ask the MasterCLASS members
for an example on how to solder a
component.